

Data Sheet



Article number: 021816011102

Description: Clamp with bracket and rubber
SPGU 6011. 102/30 SK

Measures

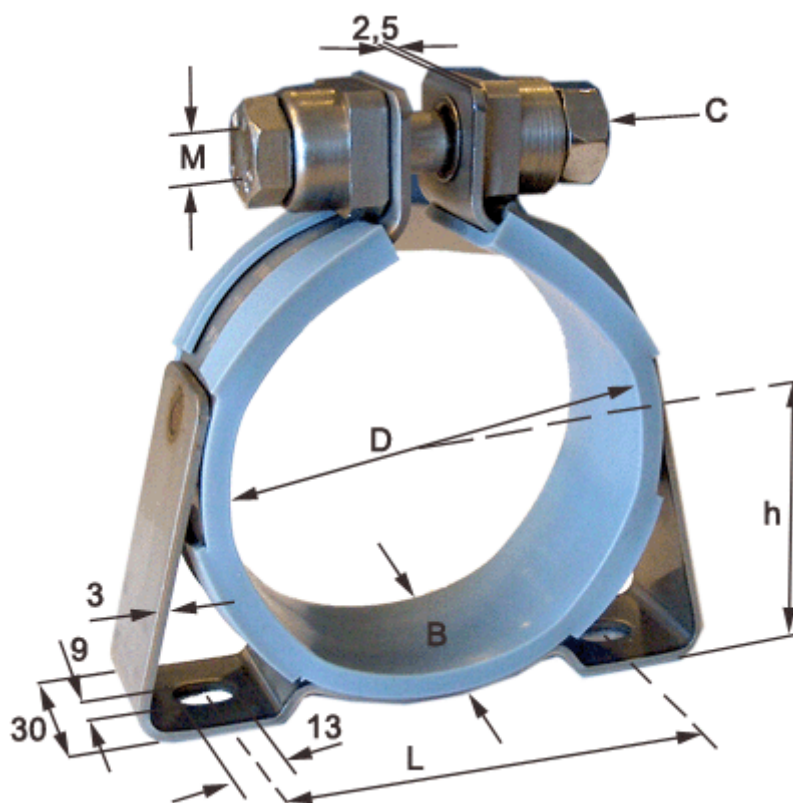

C (screw type) = SK hexagon screw

Diameter D = 102

h = 60

L = 90

Width B = 30